

# LAPUA-BASED SUBCONTRACTING NETWORK



[www.investlapua.fi](http://www.investlapua.fi)

Dear entrepreneur,

# **WELCOME TO LAPUA!**

Lapua is a city which offers well-functioning services, diverse sports, culture, and a pleasant environment with a vibrant entrepreneurial spirit and a strong cooperation network.

In Lapua, decision-making is business-oriented and fast. Lapua only offers the best for entrepreneurs: A diverse range of plots and office premises as well as flexible and professional business consultations are all readily available. Lapua boasts great logistics: it is easy to reach by car, truck, or train. An international airport and a harbor are located just a few kilometers away.



# LAPUA

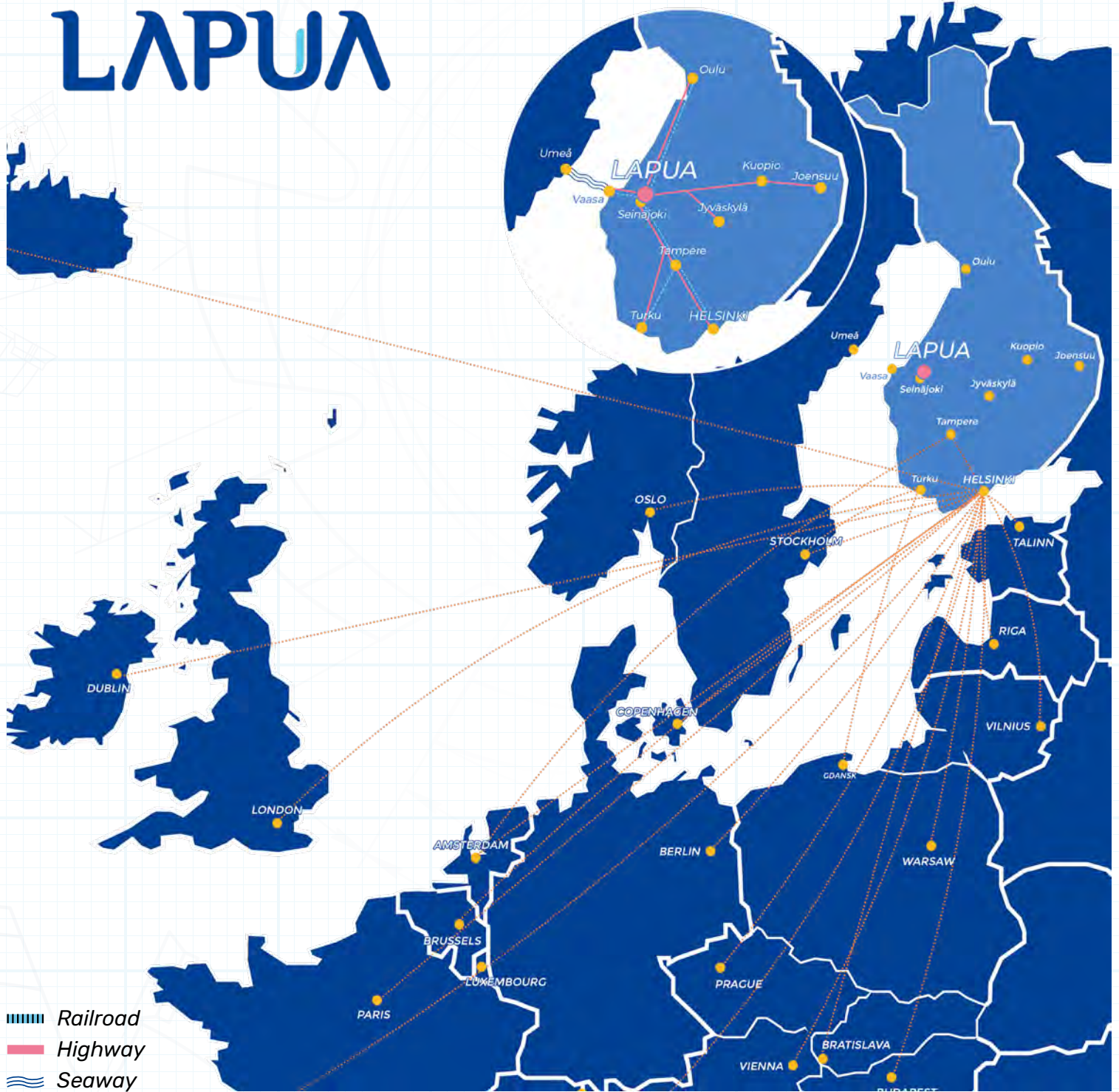

# KJ-Koneistus Oy





A subcontracting company in the metal sector, KJ-Koneistus Oy **manufacturers machine parts by lathing and milling**. The main customers are the wind power industry, lumber industry, and hydraulic gas and pressure battery industry.

Our modern machinery enables us to produce individual pieces as well as large series of items.

We manufacture bespoke metal components, and we always ensure that this is done in a way which enables us to fully satisfy our customers' needs. Even if we are a minor player in the field, we always offer the guaranteed delivery of our services. Immaculate component quality is always the goal in our production, and at the same time we also seek to be as flexible as possible in all our activities.



” Lapua is  
a great place  
for any entrepreneur.

-  Työpajantie 4, 62100 Lapua
-  +358 50 521 3093
-  kari@kj-koneistus.fi
-  kj-koneistus.fi

# PTM-Metals Oy

PTM-Metals Oy provides services for the **machining, assembly and subcontracting industries**. The customers of our second-generation companies include companies from a variety of industrial sectors, and our clientele therefore includes operators from small enterprises to large, listed companies. Our clientele includes e.g., boiler manufacturers and companies in the forestry machine industry.

Our machinery consists of CNC controlled machining tools as well as manual machines. We have a very large supply of raw materials in our production facilities which helps us respond flexibly and efficiently to the needs of our customers. Our staff consists of professionals who have worked in the industry for a long time.

In addition to professional skills, the cornerstone of our business is fast and reliable deliveries, not to mention strong customer orientation. We thus want to be, above all, a strategic partner that serves its customers to the fullest.



” The local municipality provided us with a remarkable amount of assistance for leading in a new generation of our company management. The advice and guidance we received contributed significantly to the success of the process.

📍 Kuusikontie 1, 62100 Lapua

☎ +358 40 867 4983

✉ info@ptm-metals.fi

🌐 ptm-metals.fi

# Veljekset Ala-Talkkari Oy

The subcontracting company Veljekset Ala-Talkkari Oy is a growing and continuously developing business unit **specializing in CNC machinery**. Our services are targeted to satisfy industrial needs. Our customers include machinery and equipment manufacturers as well as manufacturers of mobile machines.

We produce parts and sub-assemblies for industrial use with more than 18 machining tools and over 20 professionals. The products to be machined are mainly made in series, but we also produce individual copies. We machine a variety of materials

from plastic to special steels. Our modern and highly automated machinery ensures efficient and flexible production. The manufacturing processes are handled in accordance with customer orders from start to finish, from procurement to surface finishing, welding, and heat treatment.

The high quality as well as the security of supply of our products are guaranteed by our long experience in the field, our skilled personnel, and our versatile machinery. Our competitiveness is based on frequent investments and the continuous development of our business.



- 
-  Hellanmaantie 619, 62130 Hellanmaa
  -  +358 6 433 6333
  -  myynti.koneistamo@ala-talkkari.fi
  -  ala-talkkari.fi



” Lapua provides entrepreneurs with excellent opportunities for networking in our field. The local municipal services help us further process our products and enable us to deliver larger orders to our customers.



Logistically, Lapua enjoys an excellent location, so it is easy to facilitate the flow of goods in a timely manner. Furthermore, there is plenty of trained workforce readily available.



# Helasteel Oy





Helasteel Oy is **a machine shop specializing in welding and turnkey deliveries.** We deliver even the most demanding orders to customers in Finland and abroad. We can deliver orders both in series and as individual projects. Our clientele consists of operators in the energy and process industries.

A large network of suppliers and modern technology ensure the rapid delivery of orders. Thanks to our certified and standardized systems, we are also capable of quickly adapting our processes to changing situations as necessary.

We never compromise on quality, efficiency or reliability. These values are visible in all our activities as are open cooperation and long customer relationships. For us, quality welding is a matter of honor, and our company only hires the professionals in the field. Solid skills and professional competence are among the key factors ensuring our first-class services. Our goal is to grow and become an ever stronger player in the field.

---

 Kelohongantie 6, 62100 Lapua

 +358 10 583 5800

 [info@helasteel.fi](mailto:info@helasteel.fi)

 [helasteel.fi](http://helasteel.fi)



” It makes good sense to set up a business in Lapua. The central location of the town and its good logistical connections provide a definite advantage.



# Plate Power Oy

---

Plate Power Oy **provides subcontracting services in the metal industry and specializes in laser cutting, metal panel cutting, edging, and welding.** The company is a reliable operator with solid experience gathered since 2002. Networking and contractual freight services enable us to serve our customers across the whole of Finland. Our customers mainly consist of machine and equipment manufacturers working in the fields of tractor, train, shipbuilding and construction industries as well as of companies involved in projects aimed at developing healthcare work environments.

Our goal is to bring added value to our customers in a cost-effective manner. Continuous production development, skilled personnel and modern, efficient machines ensure optimum quality. The projects we carry out involve work varying from individual components to detailed sophisticated component assemblies and surface treatments. Our ability to react quickly ensures that our customers' interests are always satisfied in an optimal, effective way. Our adaptive and modern processes are the cornerstone of our competitiveness.

- 
-  Suutalantie 5, 62100 Lapua
  -  +358 50 555 0918
  -  [paavo.hyyppa@platepower.fi](mailto:paavo.hyyppa@platepower.fi)
  -  [platepower.fi](http://platepower.fi)

# MA-Tech Oy

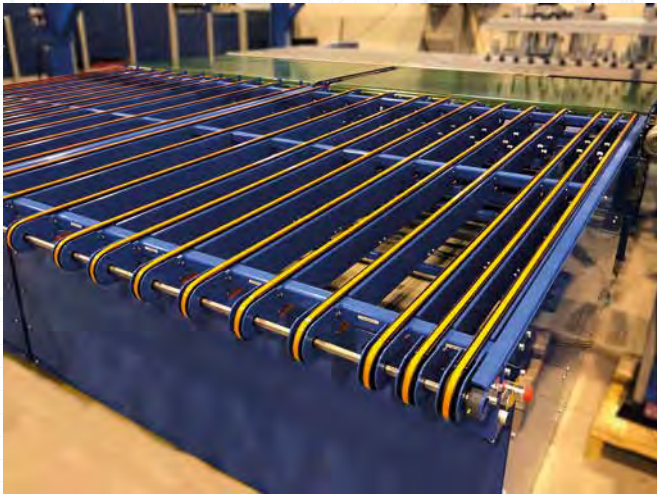



MA-Tech Oy, a specialist in material processing and production efficiency, **manufactures bespoke conveyors for industrial purposes.** Our customers include operators from a variety of industrial sectors, with the metal industry constituting the largest individual segment.

Our cost-effective products quickly benefit our customers in an efficient manner. Both planning and manufacturing take place in our Lapua premises from start to finish, which ensures that our quality products will be available at reasonable prices. However, we also perform dimensioning and specification visits to customers throughout Finland.

Especially since the change of ownership in 2014, MA-Tech has shown strong growth and has been steered in a growth-oriented direction. Depending on the industry concerned, we are definitely the most dynamic player in the marketplace with regard to both service and case management. We deliver the product to our customer as a new or as a replacement investment on a turnkey principle from pre-specification to final delivery.

 Lohkarekuja 2, 62100 Lapua

 +358 10 505 7902

 [info@ma-tech.fi](mailto:info@ma-tech.fi)

 [ma-tech.fi](http://ma-tech.fi)

# Ravaltso Oy

Ravaltso Oy is a company with more than 35 years of hydraulic cylinder experience. **We manufacture, sell, and service hydraulic cylinders.** We also manufacture bespoke items as per customers' orders. Our clientele mainly consists of equipment manufacturers and private operators.

We use state-of-the-art technology to manufacture hydraulic cylinders. We use CNC machines, lathes, machining centers, sawmills, a welding robot, and manual machines for manufacturing products made of high-quality

materials. Our services also refurbish damaged hydraulic cylinders.

We focus on functionality and security. Our products are prime examples of domestic quality work, and our company has a AAA credit rating. Punctuality is one of our key foci, which is that we can always guarantee to manufacture products and deliver orders on time as agreed. Our target is steady growth in the domestic market.

” From an entrepreneur’s point of view, Lapua is a great place for any kind of business enterprise.

- 📍 Rantalassilantie 2, 62100 Lapua
- 📞 +358 50 465 2370
- ✉️ tuomas@ravaltso.com
- 🌐 ravaltso.com



**BUSINESS ACTIVITIES SERVING INDUSTRIAL NEEDS**

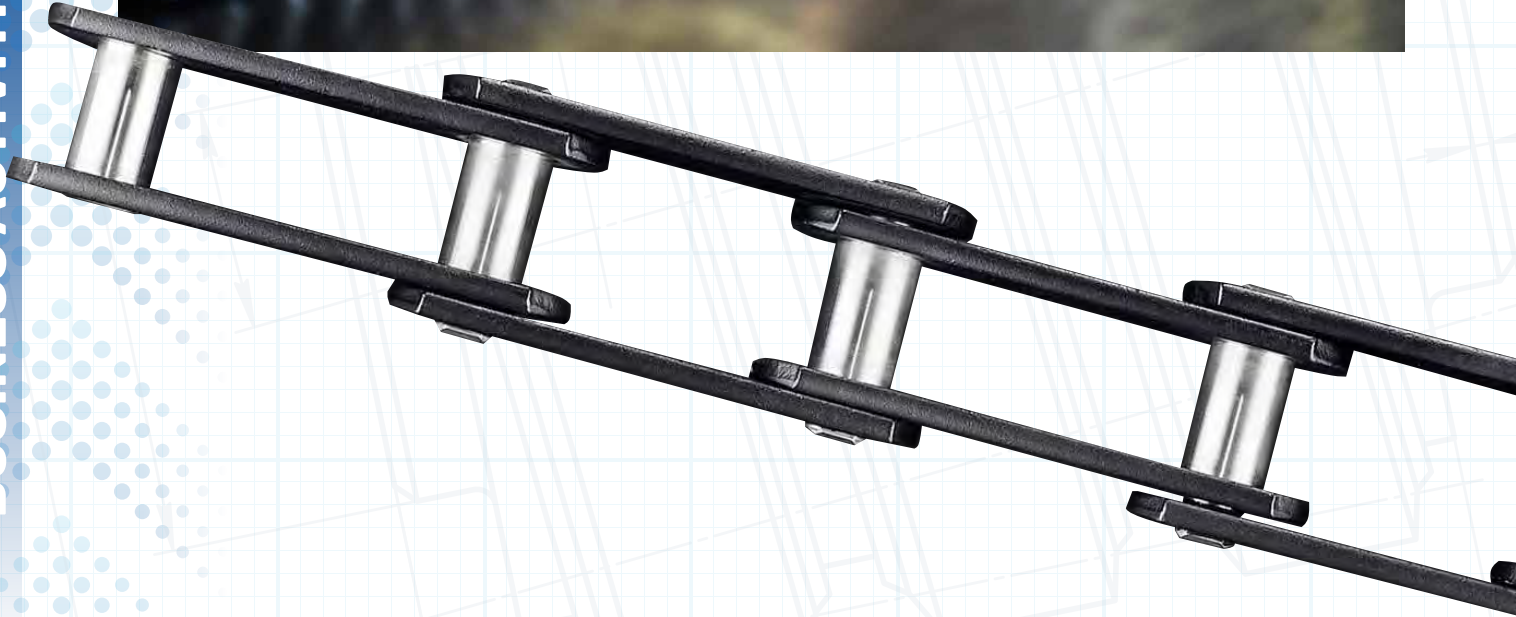

# Lapua-ketjut Oy

---

Lapua-ketjut Oy **manufactures conveyor chains for industrial conveyors and material handling systems.** Thanks to almost 70 years of experience in a range of fields, the chains we manufacture exceed industry standard requirements by a factor of several times. Our largest customer groups are comprised of lumber and thermal power industry plants and equipment manufacturers.

The chain products we offer are manufactured domestically from start to finish, which contributes to short manufacturing periods even for bespoke products. Professional competence and first-class manufacturing methods ensure durable products of high quality. Sustainability is achieved by a

sophisticated combination of the right raw materials and their heat treatment. Superior resistance to wear ensures that our products are profitable in the long term by reducing the number of chain breaks and by enabling smooth production.

Our skilled customer service can help you with your chain selection, dimensioning, and mapping of your needs to support your maintenance and procurement activities. We also perform analyses of broken chains. Our user-friendly services and our deep understanding of the customer's needs provide a good platform for finding customer-friendly chain solutions.

” Lapua is located in the center of the province of Southern Ostrobothnia, right next to a major highway. Lapua is easy to reach from any place, and there is plenty of workforce available.

---

 Patruunatehtaantie 13, 62101 Lapua

 +358 6 435 1200

 posti@lapua-ketjut.fi

 lapua-ketjut.fi

# Jusmara Oy

Jusmara Oy operates in the mechanical engineering industry field. **We deliver a wide range of components and subassemblies manufactured according to the client's drawings and wishes.** Our customers include both major companies in the metal industry operating on the large international market and smaller local operators.

Our company has its roots in the 1960s. In those days, production mainly consisted of various agricultural items. In 1988, a new generation stepped in, and since then, especially in recent years, our activities have increasingly focused on subcontracting. In this field, the services we offer include **machining, laser cutting, edging, lathing, drilling, sawing, tube bending, assembly, sandblasting, painting, and design.**

Flexibility is an essential part of all our activities. This is reflected in our services as our ability to react quickly, and in our production as varying sizes of production



series, from a few pieces to thousands of items produced.

In addition, quality and security of supply are important to us. Both are ensured by the availability of a wide range of production technologies and skilled personnel under the same roof. Our production is also complemented by a number of subcontractors.

” In Lapua  
you can enjoy  
a truly entrepreneurial  
atmosphere.

- 
- 📍 Raamatuntie 461, 62130 Hellanmaa
  - 📞 +358 50 016 3144
  - ✉️ simo.ala-rantala@jusmara.fi
  - 🌐 jusmara.fi



# Inducing Oy



Inducing Oy **manufactures thin plate parts and their related components up to full assembly.** Our clientele includes various types of operators from the producers of glass manufacturing machinery to manufacturers of electrical table components. We produce parts, such as curing oven conveyors and trailer parts.

A strong commitment to the workplace on the part of the staff ensures that we can operate flexibly whenever necessary. Strong adaptability combined with reliability in all our activities ensures quality results.

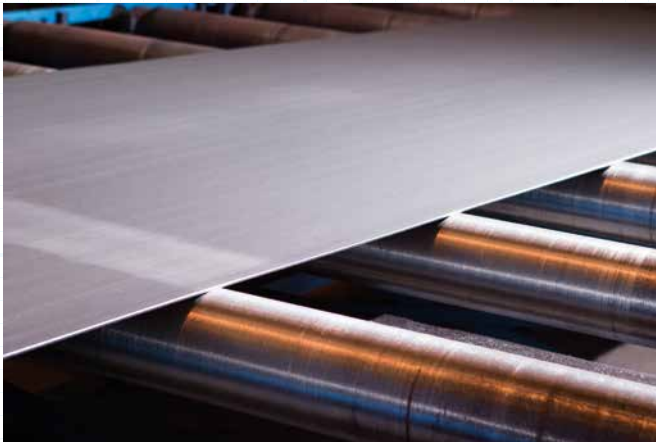

---

 Tuomaantie 1, 62100 Lapua  
 +358 50 567 2311  
 ari.ikola@inducing.fi  
 inducing.fi

## Mever Oy







In addition to subcontracting, Mever Oy also **produces recycling and storage systems for homes, commercial enterprises and public spaces**. The plastic parts of our products are made of recycled plastic while other products are made of metal wire, thin plates, and aluminum. Our products are mainly purchased by chains, wholesalers and kitchen and furniture manufacturers, who sell the products to end users as such or as part of their own products. Our entire production is of domestic origin.

The very basis of our activities is competent and professional personnel, not to mention efficient machinery and production lines. These key factors in turn are responsible for the high quality, flexibility and competitiveness of the company as a whole.

In the future as well, it will be important for us to be able to keep our customers, our employees and other stakeholders satisfied. In product development too, we pay special attention to meeting customer needs and facilitating our customers' daily lives. Long experience in the sector guarantees innovative solutions and continuous development.

” Lapua is  
a great place for any  
entrepreneur:  
good accessibility and  
good connections.

- 
-  Tuomaantie 19, 62100 Lapua
  -  +358 50 550 4585
  -  [samuli.kylkisalo@mever.fi](mailto:samuli.kylkisalo@mever.fi)
  -  [mever.fi](http://mever.fi)

# Tooltek







Founded in 1991, Tooltek **imports, manufactures and services edging and cutting blades for industrial use.** Our clientele includes companies in the lumber, metal and food industries as well as municipalities and private operators.

We manufacture edging blades in both standard and bespoke dimensions. Bespoke orders are always executed according to the customer's needs. The design of special size blades is carried out by 3D simulation, and a 5-axle CNC grinder is used in the manufacturing process. If they so wish, the customers can also have their metal industry grade mills and drills coated with their preferred coating.

” For entrepreneurs, Lapua is a great place where you can get a lot of support from other companies.

---

 Ritakulma 2 B, 62100 Lapua  
 +358 500 350 834  
 kari.kallioniemi@tooltek.net  
 tooltek.net

# JSA-Group Oy

JSA-Group Oy provides services for the mechanical installation, maintenance and modernization of power plants. We install fixed biofuel treatment systems for power plants, paper industry conveyor systems, sawmill industry conveyor systems, systems for the transfer and handling of bulk goods, as well as food industry conveyors and equipment. Our customers include device manufacturers which sell their products on a global scale.

The key factors our company focuses on daily are the high quality of products and the utilization of the competence of our highly skilled employees. Our business is based on long-term customer relationships and trust. In addition to our solid experience, our core activities are based on customer

” A small town makes it easy to run a business.

orientation, which also guarantees that our projects will turn out successful and smooth. The installations are always conducted in a transparent and efficient manner.

📍 Lohkarekuja 1, 62100 Lapua

📞 +358 40 734 0713

✉️ henri.alahuhta@jsa-group.fi

🌐 jsa-group.fi



# Maint Way Oy



Maint Way Oy is a company specializing in maintenance services for the mechanical engineering industry and focuses on **forecasting solutions to problems with CNC machining tools and providing the requisite solutions.** The company also provides services for eccentric edging and other presses, laser cutting, oxygen cutting and plasma cutting machines, saws, Fanuc robots, welding machines, and all related accessories. Our clientele typically consists of subcontracting workshops and other companies providing manufacturing services, both within the Ostrobothnia region and in more remote locations.

The MW-Maint machine health management system developed by our company is responsible for monitoring the operation of

all the equipment we maintain. Our services ensure reliability and continuity for the production of our customers and enhance the machinery utilization rate.

Detailed resource management ensures rapid integration in the event of unexpected errors in customer equipment. Our business is thus based on a customer-oriented approach backed up by solid experience. We provide our customers with reliable services in a customer-oriented manner.

📍 Kotakuja 8, 62100 Lapua

📞 +358 10 322 5450

✉️ info@maintway.fi

🌐 maintway.fi



# Santala Print Oy

” Lapua is  
a great place  
for any entrepreneur.

Santala Print Oy **produces large format prints, advertising stands and labels,** and has 50 years' experience in the business. A second-generation professional approach and advanced production facilities ensure a first-class result for your bespoke order. Our customers come from all sectors, both domestic and international. Part of the company business consists of subcontracting work for customers from the graphic design industry.

Our high-quality advertisements enhance the customer's visibility and bring their visual look to life. We have invested heavily in new equipment and machines to make our company a state-of-the-art business even on a European scale. All products are manufactured under the same roof, enabling accurate production and precise quality control. We fulfill the wishes and satisfy the needs of our customers by new innovations backed up by our long experience in the business. We find it very important to bring versatile, customer-oriented services to the market. Continuous development and reliability play a key role in our business.

---

 Louhekuja 4, 62100 Lapua

 +358 50 555 2911

 turo@santala.net

 santala.fi

# Suomen Hitsauspalvelu Oy



Established in 2003, the company is a **certified welding professional**. With the help of our 19 professionals, we can handle large-scale projects, many of them abroad. In addition to our domestic projects, foreign work sites are also readily handled by our company.

Our expertise mainly consists of different types of certified welding, such as pressure boilers. Work is usually based on annual contracts with major operators, but we are always happy

to discuss the possibility of new contract customers. Our company also **provides you with services for various demanding welding, installation, measurement and control projects.**

📍 Tiitunpolku 1, 62100 Lapua

📞 +358 500 661 801

✉️ jari.laitinen@netikka.fi



# M. Alakojola Service



---



M. Alakojola Service **operates in the field of industrial maintenance by offering personnel and machinery leasing services to their customers.** Our services are directed at large industrial maintenance operators, plant manufacturers, other machinery rental companies and also private persons.

The very basis of all our business is a successful combination of high-quality work and well-working schedules. Completing projects within the agreed time limits is of paramount importance in industrial contexts, and this is why we never compromise on schedules. This will ensure smooth project continuity. Thanks to solid 30 years' experience, we have learned to run our business in a way that fulfills the customer's wishes.

---

 Kuortaneentie 353, 62100 Lapua  
 +358 40 056 4723  
 [markku.alakojola@gmail.com](mailto:markku.alakojola@gmail.com)

# PP-Hydraulics Oy

PP-Hydraulics Oy **provides services for the installation, repair and design of hydraulic equipment and devices.** Part of the global ParkerStore network, our accessory sales offer you an extensive selection of hydraulic hoses and connectors, tubing accessories, valves, pumps and motors as well as filters and lubricants. Our customers include Finnish machine manufacturers, industry, and contractors.

We design entire hydraulics systems, including the necessary documentation. In addition, we perform maintenance, repairs and system changes and modifications, either in our

workshop or at the customer's site. We also have extensive experience of plumbing installations in the mechanical and chemical wood processing industry, oil refineries, water and wind power plants, food industry, and metal and mechanical engineering industry.

A customer-oriented approach is at the very heart of our business. We aim to maintain our ability to react to any situation by stockpiling products continuously used by customers and by keeping the delivery times of our other products competitive. We use top quality products from leading manufacturers to ensure high quality.







- 📍 Honkimetsäntie 24, 62100 Lapua
- 📞 +358 10 666 6020
- ✉ myynti@pphydraulics.fi
- 🌐 pphydraulics.fi

# Fintec Oy



Established in 2003, Fintec Oy is a company specializing in the import and sales of Chesterton service and maintenance products as well as ARC coatings. Our premises and warehouse are located in Lapua. Our business also handles various industrial washing and cleaning projects, concrete and metal coatings as well as sandblasting and shot blasting and surface treatment. Our customers include companies from the paper and pulp industry, power plants, thermal power plants, metal industry, etc.

We provide you with services, employing professionals with more than 20 years of experience in the field. Chesterton technical maintenance products are specifically designed for demanding industrial lubricating, cleaning and sealing projects. Chesterton ARC composites are designed for use in locations where concrete and metal items are susceptible to wear, corrosion and aggressive chemicals.

- 
-  Kotametsäntie 3, 62100 Lapua
  -  +358 6 414 4111, +358 400 721 330
  -  [fintec@fintec.fi](mailto:fintec@fintec.fi)
  -  [fintec.fi](http://fintec.fi)

# Techat Oy

Techat Oy is a technology company established in 2014. The company provides its customers with **comprehensive product development services, circuit design, programming of embedded systems, and product development consultation.**

Our experts have more than 30 years of experience in the field of electronic solutions and embedded systems. We always seek to ensure that the technology we produce is the most reliable part of the product.

Techat has the capacity to build a technological product for your company from an initial idea to the finished product. We can also prepare a cost-effective prototype or proto series based on the customer's ready-made design.

Techat Oy is a service partner to Business Finland whose innovation voucher has become a popular service. The voucher provides a customer with a total of EUR 5,000 worth of product development work in return for an investment of EUR 1,000.

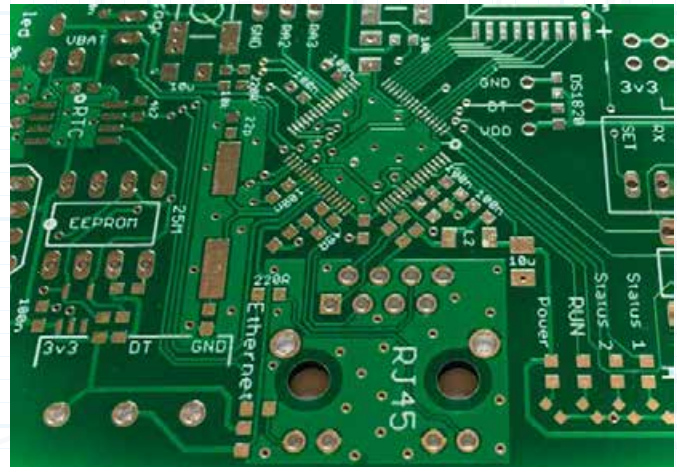
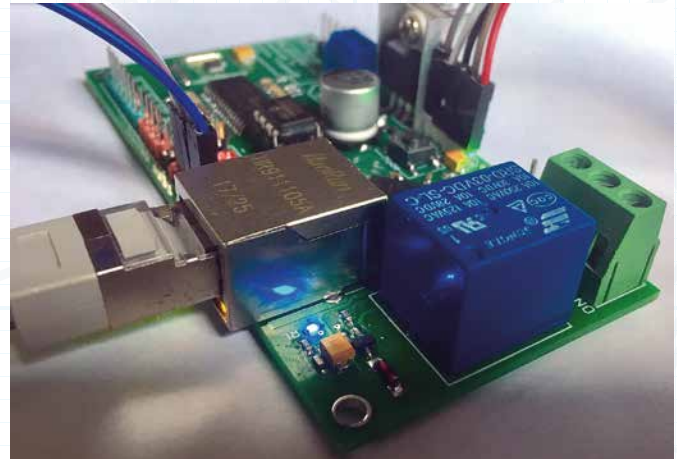

-  Yhdystie 74, 62290 Hirvikylä
-  +358 44 984 4257
-  myynti@www.techat.fi
-  techat.fi

” In Lapua  
businesses reach  
their targets!

# Tehotec Oy

Tehotec Oy offers **industrial internet services**. Developing company production and innovative solutions is based on solid experience in a number of business sectors. Efficient production ensures that products and services are competitive, without compromising on profitability. Our clientele consists of domestic and international export companies engaged in manufacturing.

For product development, we offer the HitScan cloud service, which provides an efficient, safe and flexible solution for monitoring the use of industrial machinery. An accurate real-time understanding of the efficiency and bottlenecks

of the production process enables optimal coordination and monitoring of remedial measures. The HitScan service has a rapid impact on the company's operational efficiency and profitability by enhancing the flow of the production process.

The cornerstones of our service are ease, speed, and security. We provide companies with visual data on the current utilization rate, which enables the management to take the necessary steps to streamline the production process. Innovative solutions and continuous development are an essential part of our business.

” Lapua is a great place to live and run a business.

- 📍 Teollisuustie 5, 62100 Lapua
- ✉️ juha.lemponen@tehotec.fi
- 📞 +358 50 446 0030
- ✉️ mika.latvala@tehotec.fi
- 📞 +358 50 463 3341
- 🌐 tehotec.fi



# HR Roihu Consulting Oy

HR Roihu supports its customers with a strategic approach, an operational strategy, and practical consultation on personnel administration at all stages of the organization's life cycle. HR Roihu is your solution-oriented and versatile professional partner for flexible cooperation. HR Roihu consultants can provide a view on the construction and development of HR processes and tools and use their experience on change management issues and integration projects, or they can support the development and well-being of the personnel at work in your organization.

The HR Roihu service package is tailored to the needs and conditions of the customer's organization, and it is therefore possible to manage HR in a client-specific manner.

When the content and quantity of the work varies or the organization lacks HR expertise,

an outsourced version of HR may be the appropriate solution. Project aid is an excellent way to get a service when there is distinctly an individual need for an HR professional. When it is necessary to have an HR professional to share ideas at a time when strategic means are being considered, sparring is the preferred way of acquiring a service before any decisions are made or before a roadmap and objectives are defined.

Consistent HR work helps your staff develop and commit themselves. It also reinforces the prerequisites for the success of the organization and creates a competitive advantage for better results in your business. When you want to succeed by determined personnel management, the HR Roihu professionals are there to help you!



+358 40 724 9985

elina.harju@hrroihi.fi

hrroihi.fi

# Export Maker

Export Maker is an expert in international trade. Our passion is to **help companies with internationalization and export processes**, and more importantly, speed up international growth through concrete means.

Being too modest does not get you anywhere. That is why we help your company shine and grow by showcasing your existing capabilities and developing new ones. Strategic thinking and a passion for international trade runs through our veins, which makes us a

great partner to begin and continue your internationalization! With more than 1000 projects executed, we have helped companies in the most challenging business environments create new business opportunities.

Our special market areas are the Nordic countries, Central and Southern Europe, Eastern Europe, China, North America, and the Middle East. Always local service. We have local experts more than 30 market areas.



Export Maker is making exports happen and we believe that one day Finland will export more than import.



📍 Kauppakatu 28 A 59, 40100 Jyväskylä  
📞 +358 50 036 5851  
✉️ juha.lahtinen@exportmaker.fi  
🌐 exportmaker.fi

📍 Jyväskylä, Helsinki, Lapua,  
Chicago, Montreal, Tours,  
Barcelona

# Establish your business in Lapua



Excellent location logistically, plots of different sizes, skilled and committed labor, cost-effective operating and production facilities combined with the region's strong entrepreneurial network provide a successful framework for your business.



Parasta  
yrittäjille

[investlapua.fi](http://investlapua.fi)

## STRATEGIC SELECTION

The entrepreneurial and business orientation of municipal decision-making is the cornerstone of our business policy. We can quickly and flexibly respond to your request for business premises.

## GOOD LOCATION

Lapua is located on excellent transport and communication routes next to highways 16 and 19 at the intersection of highway 66. We are easy reach by car or by even heavier vehicles, as well as by train. Traffic volumes are around 16,000 vehicles per day. A train journey to Helsinki or Oulu takes just under 3.5 hours. An international airport and a harbor are both located just an hour's drive away.

## A NETWORK OF ENTERPRISES AND ENTREPRENEURS

In Lapua, business cooperation is straightforward. SMEs in our region are flexible and quick to serve the different needs of companies. If we cannot find the operator you need in more than a thousand companies in Lapua, we will certainly find the one you need in our network of several thousand companies in the neighboring municipalities.

## PERSONNEL

Skilled labor is the most important resource in a modern business. It has been established by research projects that the inhabitants of Lapua are remarkably satisfied with the municipal services available and that they also have a strong sense of security. New schools and extensive recreational services available throughout the year are some of the factors which make Lapua a highly attractive town to live in. There are more people moving into the town than people leaving the town.



## PREMISES AND PLOTS

- affordable price level
- operating and production facilities of different sizes
- plots of different sizes on solid ground with logistically good locations along highways
- eligibility for 20% investment subsidy
- low real estate tax
- flexible land use planning
- strong business network

## BUSINESS COUNSELING

- free personal consulting services
- easily accessible
- rapid response and tailored services
- financial advice
- project counseling
- business start-up advice



” Our promise:  
There is no such thing  
as an impossible thing!

- Our team is a good counsellor,  
and it's even better when it comes to  
listening to what people have to say -  
Through genuine interest and open  
debate, we seek to identify situations  
and needs whose very existence may  
not yet be known to entrepreneurs  
and businesses.



”

The Alanko region right next to the town center is growing and developing continuously. The region is suitable, for example, for retail businesses and companies providing services.

*Plots under construction available in the Alanko region.*



”

There is an area already available for traffic-related and retail trade businesses in the NovaPark area at the intersection of highways 19 and 16.

*Illustrative view of the opportunities offered by NovaPark.*



InvestLapua provides services for your company in business matters – whether you need more information about other companies in Lapua and their products, plots, premises or other business services, including various development projects and funding.

Companies in our region can help you in virtually all challenges, “from the construction of a submarine up to becoming a component manufacturer for new jet fighters”.

InvestLapua is there for companies.



” Establish your business in the Jouttikallio region.  
It will help your business grow in the middle of  
cooperation networks.

Read more about entrepreneurship opportunities  
and entrepreneurship in Lapua:

[www.investlapua.fi](http://www.investlapua.fi)



info@investlapua.fi | +358 44 438 4050 | +358 44 438 4015